

# AIPHONE

## JP-4HD

### HANDS-FREE COLOR VIDEO INTERCOM SUB MASTER STATION

## INSTALLATION & OPERATION MANUAL

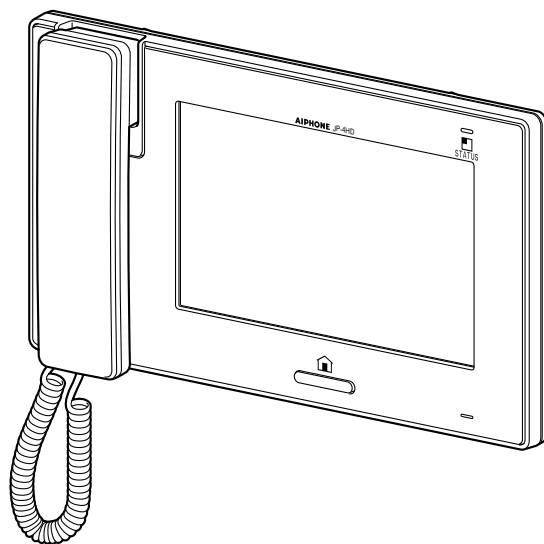

Thank you for selecting Aiphone for your communication and security needs. Please read this manual carefully before using this system.

\* Please make sure to read this manual for safe and correct use of the system, and keep it in a safe place for future reference.

Please note that images and illustrations depicted in this manual may differ from the actual product.

# CONTENTS

<b>PRECAUTIONS</b> .....	<b>4</b>
<b>WARNING</b> .....	<b>4</b>
<b>CAUTION</b> .....	<b>4</b>
<b>GENERAL PRECAUTIONS</b> .....	<b>4</b>
<b>NOTICES</b> .....	<b>5</b>
<b>PACKAGE CONTENTS</b> .....	<b>5</b>

## **INSTALLATION** .....

<b>CONNECTIONS</b> .....	<b>6</b>
<b>Notes about handling cables</b> .....	<b>6</b>
<b>Basic connection methods</b> .....	<b>7</b>
<b>Connecting external devices</b> <b>(using the option connector)</b> .....	<b>8</b>
<b>MOUNTING</b> .....	<b>8</b>
<b>Mounting locations</b> .....	<b>8</b>
<b>Mounting procedure</b> .....	<b>9</b>
<b>SETTINGS AFTER</b> <b>INSTALLATION</b> .....	<b>10</b>
<b>[INSTALL] menu</b> .....	<b>10</b>
<b>Assigning an ID to station</b> <b>[ID SETTING]</b> .....	<b>11</b>
<b>Initializing station [INITIALIZE]</b> .....	<b>11</b>
<b>Identifying software version</b> <b>[SOFTWARE VERSION]</b> .....	<b>11</b>

## **PART NAMES**.....

<b>Front panel</b> .....	<b>12</b>
<b>Screen</b> .....	<b>13</b>

## **SETTING AND ADJUSTMENT** .....

<b>SETTING LIST</b> .....	<b>14</b>
<b>SETTING AND ADJUSTMENT</b> <b>DETAILS</b> .....	<b>15</b>
<b>Setting the PIN</b> <b>[GENERAL] - [PIN SETTING]</b> .....	<b>15</b>
<b>Call settings [CALL]</b> .....	<b>15</b>
■ Designate door stations allowed to call-in to this station <b>[DOOR STATION SETTINGS]</b> .....	<b>15</b>
■ Designate residential station(s) that receive a call from this station <b>[ROOM STATION CALL SETTINGS]</b> .....	<b>16</b>
<b>Setting the microphone on/off for</b> <b>a call from a residential station</b> <b>[TALK] - [PRIVACY MODE]</b> .....	<b>16</b>
<b>Setting for indoor monitoring</b> <b>[MONITOR] - [ROOM MONITOR]</b> ....	<b>16</b>
<b>Enabling/Disabling the operation</b> <b>sound</b> <b>[GENERAL] - [SOUND SETTING] -</b> <b>[AUDIBLE TOUCH TONE]</b> .....	<b>17</b>
<b>Enabling/Disabling door release</b> <b>[GENERAL] - [DOOR RELEASE]</b> ....	<b>17</b>
<b>Adjusting brightness and volume</b> <b>[ADJUST]</b> .....	<b>17</b>

## **USING THE SYSTEM**.....

<b>ANSWERING A CALL</b> .....	<b>18</b>
<b>Answering a call from a door</b> <b>station</b> .....	<b>18</b>
■ Receiving a call while talking with another door station.....	<b>19</b>
■ Receiving a call while talking with another residential station.....	<b>19</b>

**Answering a call from another residential station ..... 19**

- When PRIVACY MODE is set to "ENABLE" .....19

**Adjusting the display mode for viewing images at a video door station ..... 19**

- Switching Zoom/Wide.....19
- Pan & Tilt .....20

**Adjusting images [IMAGE]..... 20**

- Adjusting screen brightness [☀] .....20
- Adjusting viewability of images [ADJUST] .....20

**Adjusting the speaker or handset volume [VOLUME]..... 21**

**Door release [DOOR RELEASE] .... 21**

**Transferring a door call to another residential station [ROOM CALL] ... 22**

**CALLING/MONITORING OTHER STATIONS ..... 23**

- Calling all residential stations simultaneously ..... 23**
- Calling another residential station ..... 23**
- Monitoring ..... 24**
  - Monitoring door station (entrance) .....24
  - Monitoring residential station (Audio only).....24

**USING THE SECURITY FUNCTION ..... 25**

**FUNCTIONS COMBINED WITH EXTERNAL DEVICES ..... 26**

- Triggering an alarm by using an external device ..... 26**
- Releasing a door with another door release button ..... 26**
- Activating an external device ..... 26**
- Using a foot switch ..... 26**

**APPENDIX..... 27**

**TECHNICAL PRECAUTIONS ... 27**

**SPECIFICATIONS ..... 27**

**WARRANTY..... Back cover**

**Term definition**

This manual uses "residential station" as the common term for "master station" and "sub master station".

# PRECAUTIONS

⊘ Prohibited

⊘ Do not dismantle unit

⊘ Keep unit away from water

ⓘ General precautions

## WARNING

### Negligence could result in death or serious injury.

- ⊘ 1. Do not dismantle or alter the unit. Fire or electric shock could result.
- ⊘ 2. Keep the unit away from water or any other liquid. Fire or electric shock could result.
- ⊘ 3. High voltage is present internally. Do not open the case. Electric shock could result.
- ⊘ 4. Do not connect any non-specified power source to the +, - terminals. Also, do not install two power supplies in parallel to a single input. Fire or damage to the unit could result.
- ⊘ 5. Do not connect any terminal on the unit to an AC power line. Fire or electric shock could result.
- ⊘ 6. Do not use power supply with a voltage other than specified. Fire or electric shock could result.
- ⊘ 7. Keep AC cord from being marred or crushed. If the AC cord is damaged, fire or electric shock could result.
- ⊘ 8. Do not plug or unplug unit with wet hands. Electric shock could result.
- ⊘ 9. Insert AC plug completely and securely into AC outlet. Otherwise, fire or electric shock could result.
- ⓘ 10. Periodically check for and remove dust on the power plug. If dust is left, it could cause the power plug to heat up, resulting in fire.
- ⊘ 11. Do not put any metal or flammable material into the unit through the openings. Fire, electric shock, or unit trouble could result.

## CAUTION

### Negligence could result in injury or damage to property.

- ⊘ 1. Do not install or make any wire terminations while power supply is plugged in. It can cause electrical shock or damage to the unit.
- ⓘ 2. When mounting the unit on a wall, install the unit in a convenient location, but not where it could be jarred or bumped. Injury could result.
- ⓘ 3. Before turning on power, make sure wires are not crossed or shorted. Fire or electric shock could result.
- ⊘ 4. Do not install the unit in locations subject to frequent vibration or impact. It may fall or tip over, resulting in damage to the unit or personal injury.
- ⓘ 5. For power supply, use Aiphone power supply model specified for use with system. If non-specified product is used, fire or malfunction could result.
- ⊘ 6. Do not put anything on the unit or cover the unit with cloth, etc. Fire or unit trouble could result.
- ⊘ 7. Do not perform a touchscreen operation with a sharp instrument such as a ballpoint pen or other metal objects. The touchscreen may get broken causing leakage of the liquid crystal inside the screen. If you get the liquid crystal in your eye or mouth, wash it away immediately.

- ⊘ 8. Do not install the unit in any of the following locations. Fire, electric shock, or unit trouble could result.
  - \* Places under direct sunlight or near heating equipment that varies in temperature.
  - \* Places subject to dust, oil, chemicals, hydrogen sulfide (hot spring).
  - \* Places subject to moisture and humidity extremes, such as bathrooms, cellars, greenhouses, etc.
  - \* Places where the temperature is low, such as inside a refrigerated area or in front of an air conditioner.
  - \* Places subject to steam or smoke (near heating or cooking surfaces).
  - \* Where noise generating devices such as dimmer switches or inverter electrical appliances are closeby.
- ⊘ 9. Do not apply high pressure on the screen. If fractured, injury could result.
- ⊘ 10. If the LCD is punctured, do not touch the liquid crystal inside. Inflammation could result. If contact should occur, flush or rinse area with water thoroughly and consult your doctor.
- ⓘ 11. Do not use the handset when you perform a call test, otherwise it may cause damage to your ear. Be sure to use the built-in speaker.
- ⓘ 12. Be sure to perform a call test with the handset on the hook. If you operate the hook switch with the handset on your ear, a sudden call etc. may arrive causing damage to your ear.
- ⓘ 13. The unit must be installed and wired by a qualified technician.

## GENERAL PRECAUTIONS

1. Keep the unit more than 1m (3.3') away from radio or TV sets.
2. Keep the intercom wires more than 30cm (12") away from AC 100-240V wiring. AC induced noise and/or unit malfunction could result.
3. Comply with all third party manufacturing specifications that will be used with this system (sensors, door releases, etc.).
4. If the unit is down or does not operate properly, unplug the power supply or turn off the POWER switches.
5. When wall-mounted, the top of the unit may darken. This does not indicate a malfunction.
6. The unit case may become warm with use, but this is not a unit malfunction.
7. If it is used close to a cellular phone, the unit may malfunction.
8. The unit can be damaged if dropped. Handle with care.
9. The unit will not work during power failure.
10. In areas where broadcasting station antennas are close by, the intercom system may be affected by radio frequency interference.
11. All the units, except for door stations, are designed for indoor use only. Do not use at outdoor locations.
12. Please note the LCD panel, though manufactured with very high precision techniques, inevitably will have a very small portion of its image elements always lit or not lit at all. This is not considered a unit malfunction.
13. Environmental sound around the unit may hinder smooth communication, but this is not a malfunction.
14. The unit has audio monitoring function between residential stations. When using this function for baby monitoring, never install the unit within reach of children to prevent strangulation with coil cord or wires.

15. Refrain from using the color monitor station in sunlit areas.
16. At night, due to reduced lighting on the object, the screen sees more noise and faces become more difficult to see, but this is not a malfunction.
17. For hands-free communication:  
If you stand too far away, it may be difficult for the other person to hear the communication.
18. If there are loud noises around the unit (such as music playing or children crying), the sound may break up and be difficult to hear.
19. During communication, if you speak before the other person has finished talking, your voice may not come through clearly. Communication will proceed smoothly if you wait until the other person has finished before speaking.
20. At a gate or porch illuminated by a fluorescent lamp, the image may vary, but this is not a malfunction.
21. The outline of video images displayed by the video door station may differ from that of the actual person(s) or background, but this is not a malfunction.
22. If the screen of a video door station freezes during wintertime, the image may become difficult to see or the call button (including the call button of audio door station) may not move, but this is not a malfunction.
23. Aiphone assumes no responsibility for corruption of saved information (such as changes to or deletion of saved information). Please be aware of this in advance.
24. Warm-color lighting shining on the video door station may change the tint of the image on the screen.
25. When outside temperature lowers sharply after rainfall, etc., the inside of the camera may fog up slightly, causing a blurry image, but this is not a malfunction. Normal operation will be restored when moisture evaporates.
26. When the unit's screen is illuminated with strong light, the image looks white or silhouetted, but this is not a malfunction.
27. When putting a hearing aid into T-mode and approaching the unit, the intercom system may be affected by radio frequency interference etc., depending on the installation environment.
28. The handset may get warm, but this is not a malfunction.

## NOTICES

- We will under no conditions be liable for damage occurring due to the inability to communicate due to malfunctions, problems, or operational errors in this product.
- We will under no conditions be liable for any damages or losses resulting from this product's contents or specifications.
- This manual was created by Aiphone Co., Ltd., all rights reserved. Copying, in part or in whole, this manual without prior permission from Aiphone Co., Ltd. is strictly forbidden.
- Please note that images and illustrations depicted in this manual may differ from the actual ones.
- Please note that this manual may be revised or changed without prior notice.
- Please note that product specifications may be changed for the sake of improvement without prior notice.
- This system is not intended for life support or crime prevention. It is a supplementary means of conveying information. Aiphone will under no conditions be liable for loss of life or property which occurs while the system is being operated.
- The discrimination between day and night is performed automatically by the door station. Though the discrimination result may vary depending on the installation environment, it is not a malfunction.

## PACKAGE CONTENTS

Verify that the following parts are included.

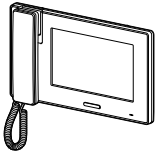
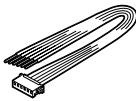
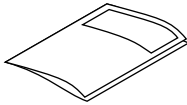
The unit	6-pin option connector	Installation & Operation Manual
		

# INSTALLATION

## CONNECTIONS

### Notes about handling cables

\* Cables and connectors are not included with the product.

#### Notes on cables (for door stations, etc.)

- Use PE (polyethylene)-insulated PVC jacket cable. Parallel or jacketed 2-conductor, mid-capacitance, non-shielded cable is recommended.
- Never use individual conductors, twisted pair cable, or coaxial cable.



#### Notes on CAT5e cables (for residential stations)

- Do not bend the cables to an extent where the radius is less than 25 mm (1"). Communication failure could result.

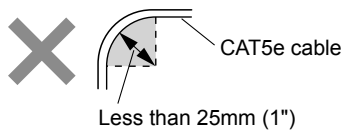
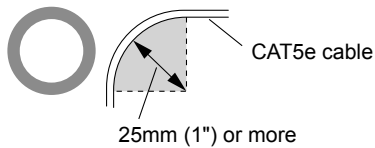

- Do not remove the CAT5e cable jacket more than necessary.
- This unit is not a computer peripheral. Do not connect it to a LAN network.

- Arrange the color code of the RJ45 connections in accordance with EIA/TIA-568A or 568B.

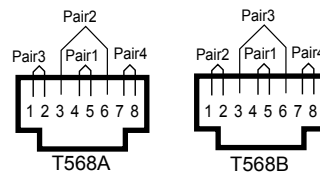

- **Be sure to check the condition of cable connections with a LAN checker before connecting with a LAN cable.**
- An RJ45 connector with a cover cannot be connected to the port for CAT5e. Use a cable without a cover.

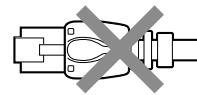

- Do not pull or put excess strain on CAT5e cables.
- Use a straight-through cable for connecting units.

## Basic connection methods

Up to seven sub master stations can be connected to the system. The connecting method for sub master stations differs depending on the system connection method, "station-to-station wiring" or "home-run wiring".

### Station-to-station (daisy-chained) wiring

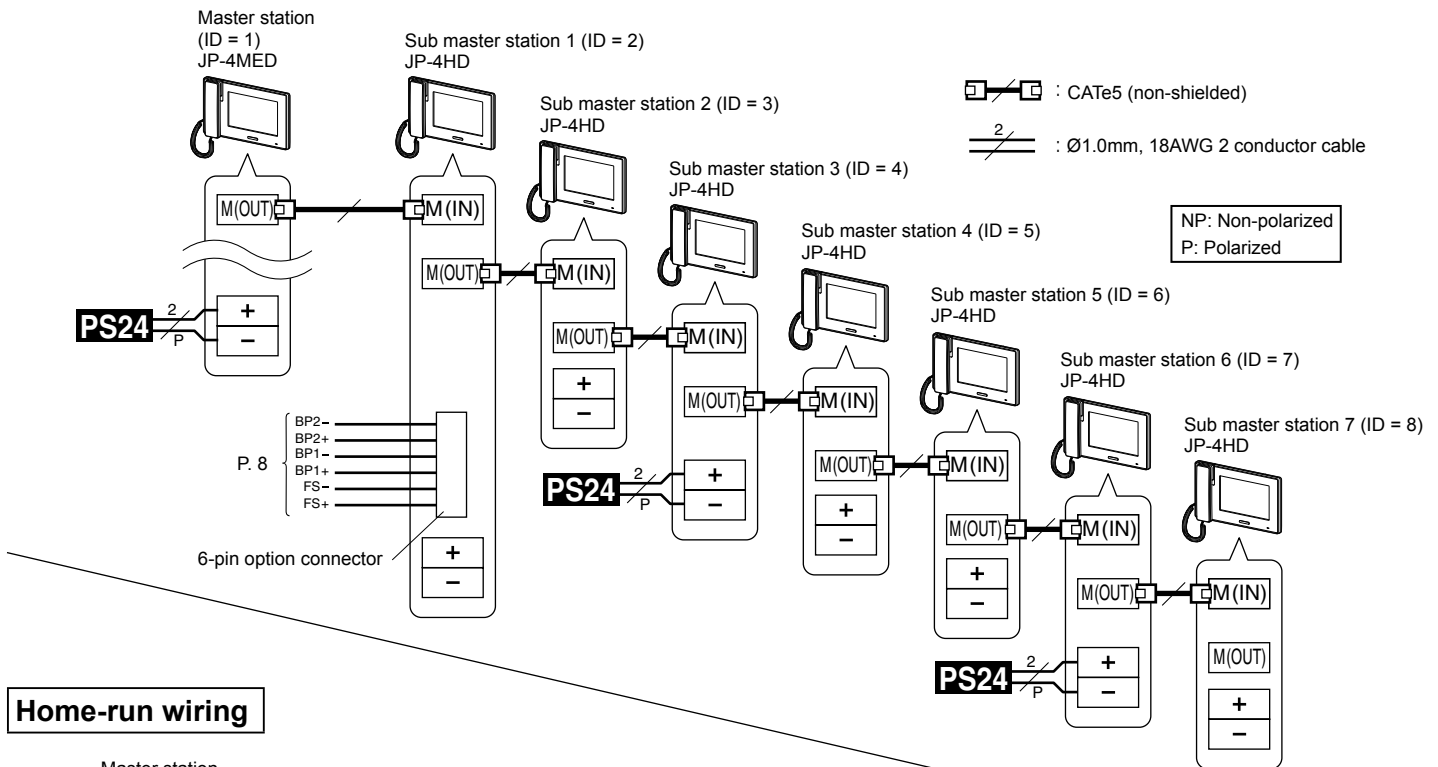

### Home-run wiring

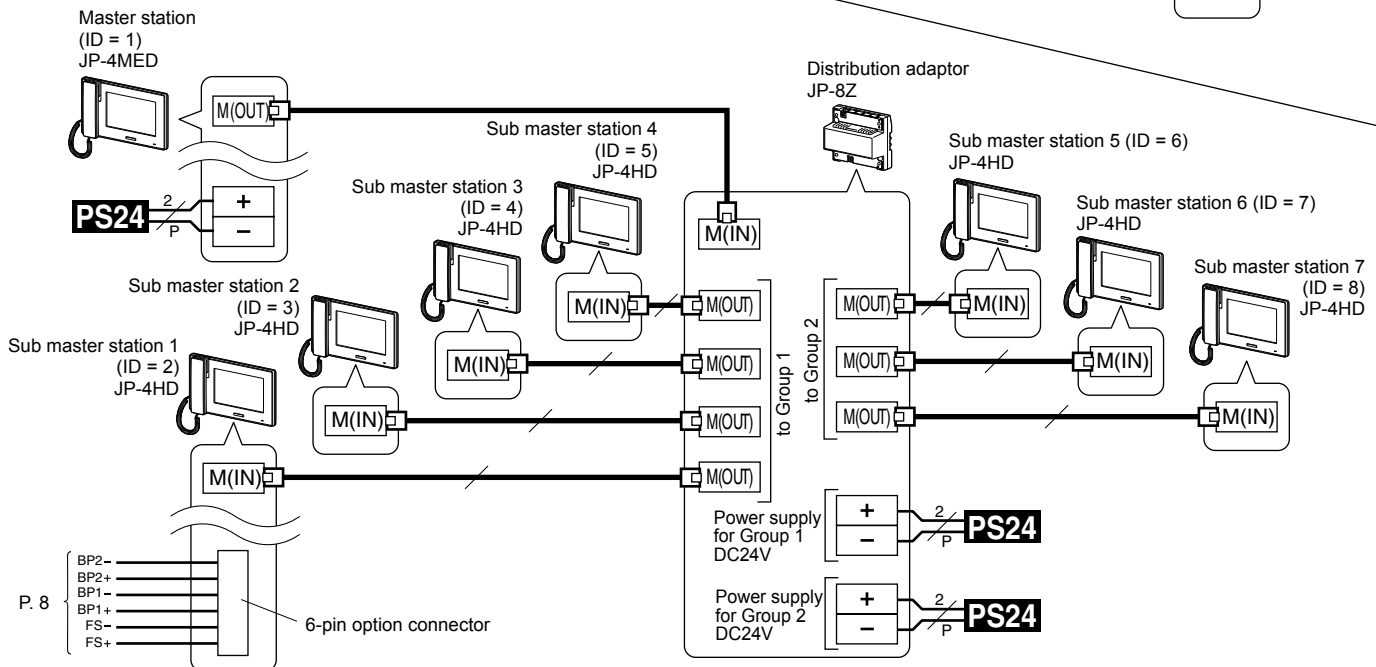

#### NOTES:

- The power supply method shown in the above figures is an example. (→ Refer to "Installation manual" for the master station)
- Do not use the unused terminals and ports for other purposes.
- In order to prevent miswiring, label both ends of each cable with the unit and terminal names to which they are to be connected.
- For connecting other manufacturers' products, refer to the instruction manuals for those products.
- The positions of the terminals on the above illustrations differ from the actual product. This is to simplify the diagram.
- This unit is not a computer peripheral. Do not connect it to a LAN network.

## Connecting external devices (using the option connector)

The 6-pin option connector of this station can be used with external devices.

### ⚠ CAUTION

- To prevent shorts, cut unused lead wires at insulation.
- Be sure to perform an operation check after the connection to check for miswiring.

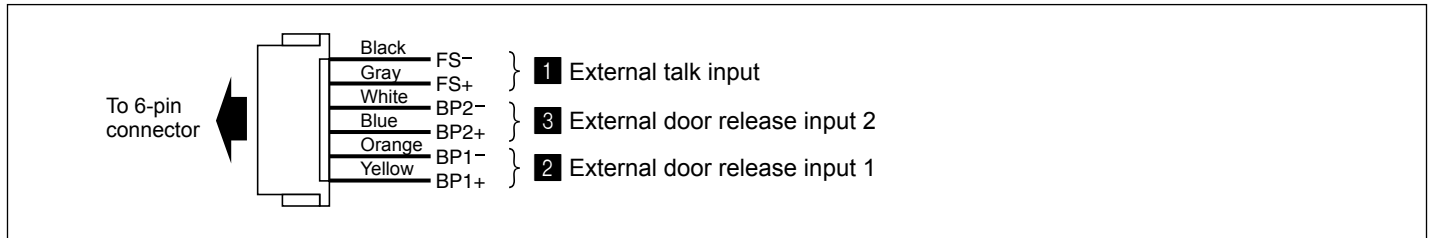

### 1 External talk input

A foot switch can be connected to operate the **TALK** or **END** function hands-free.

Input method	N/O or N/C dry closure contact (start signal only detection method)
Detection confirmation time	100 mS or more
Contact resistance	During N/O dry closure: Less than 700 Ω During N/C dry closure: At least 15 kΩ
Terminal short current	Less than 10 mA
Voltage between terminals	Less than 5 V DC (when open between terminals)

### 2, 3 External door release input 1, 2

Connect a door release button to each pair of these inputs.

Input method	N/O or N/C dry closure contact (start signal only detection method)
Detection confirmation time	100 mS or more
Contact resistance	During N/O dry closure: Less than 700 Ω During N/C dry closure: At least 15 kΩ
Terminal short current	Less than 10 mA
Voltage between terminals	Less than 5 V DC (when open between terminals)

## MOUNTING

### Mounting locations

- Install this station in a place where the screen is not exposed to direct sunlight.
- Allow at least 15 cm (6") above and 25 cm (9") below center of the mounting bracket for installation of the station.

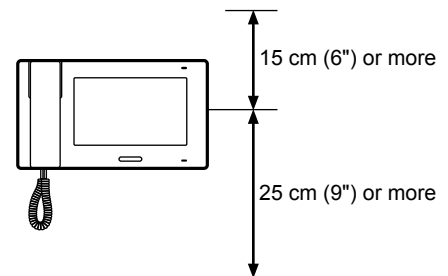
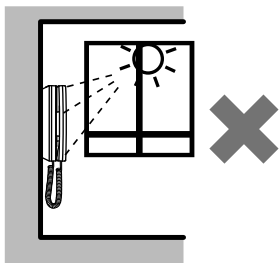



## Mounting procedure

### <Back wiring>

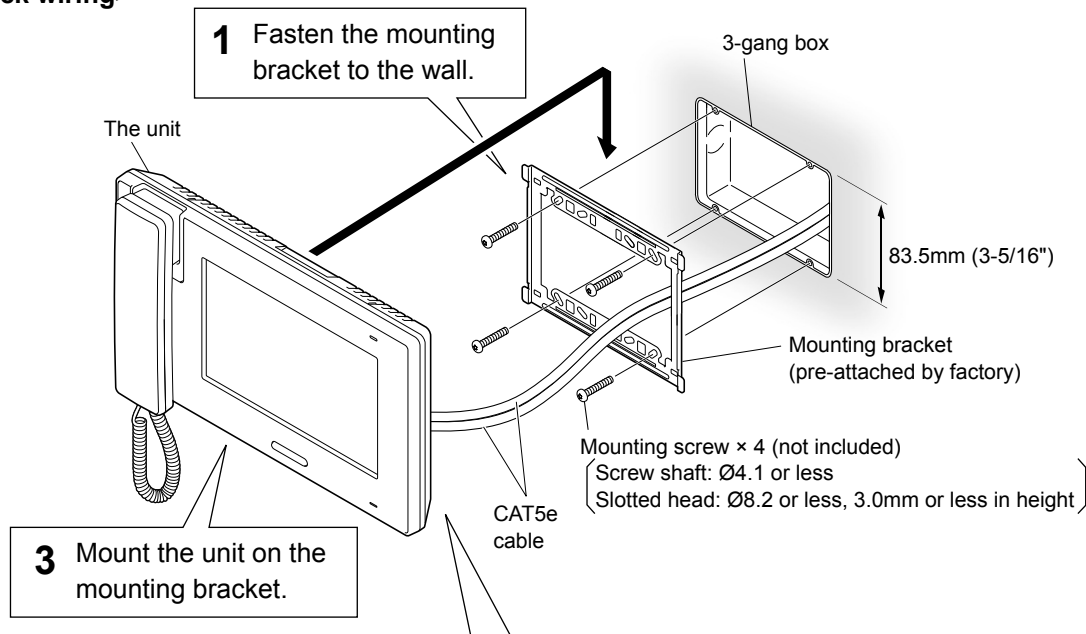

**2** Connect the CAT5e cables to the unit.

#### Opening/closing the terminal cover

##### To open:

Slide the cover to the right until it clicks, and then open.

##### To close:

Close the cover, and then slide it to the left until it clicks.

\* Make sure the cover is locked.

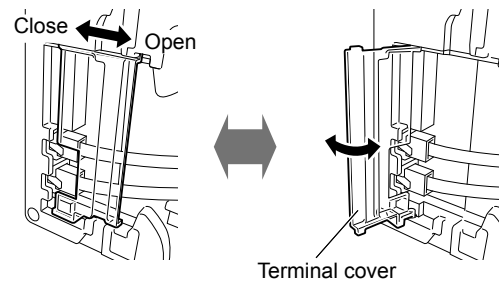

### <Surface wiring>

When the wiring is not coming through the wall, the cable and wires can be routed through the top or bottom of the cable inlet. Remove cable inlet plate on the upper part of the unit to allow passage of the wiring into the unit.

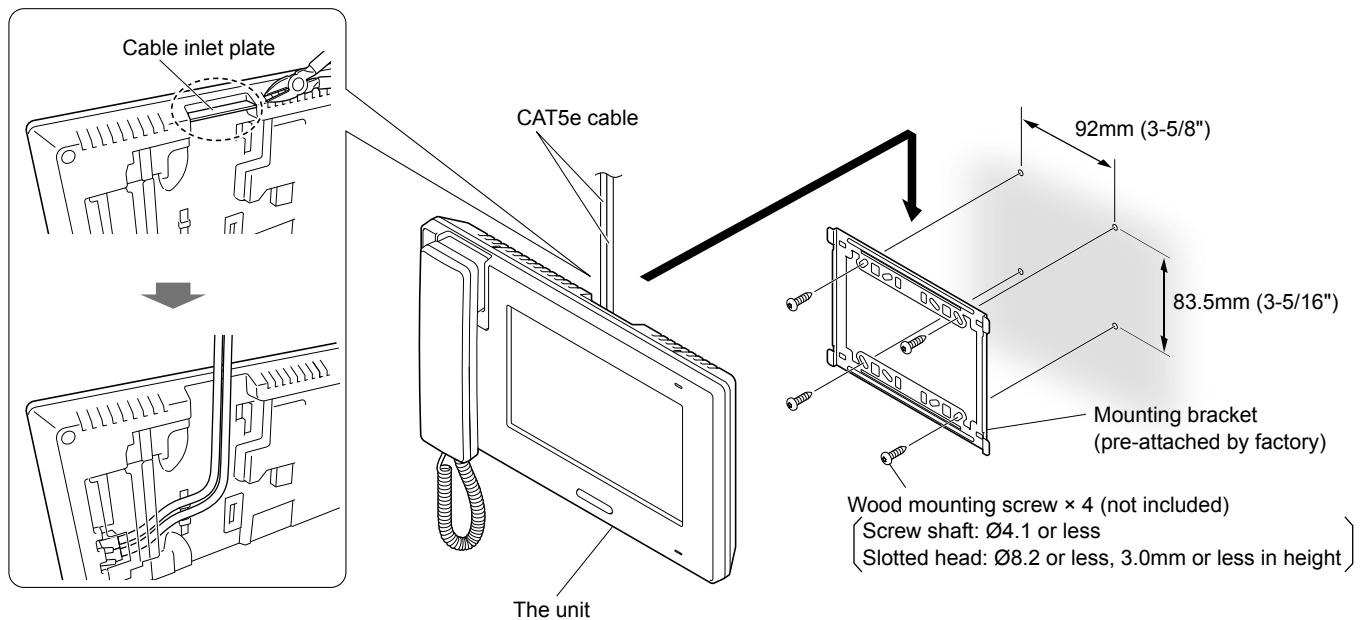

# SETTINGS AFTER INSTALLATION

The following settings should be done by the installer or the administrator of this system.  
**Be sure to assign ID to all the sub master stations connected to this system.**

## NOTE:

It is recommended to set the display language for the screen to the language needed on the master station. (Default language: English)

## [INSTALL] menu

First display the [INSTALL] menu window to make the settings for the installer.

\* The screen will turn off if approx. one minute elapses with no operation during the setting. When this occurs, display the [INSTALL] menu window again.

- 1 If screen is off, press the [HOME] button, or touch screen to turn it on.

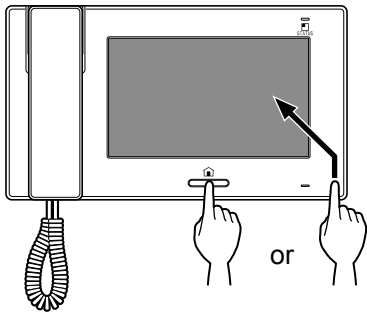

- 2 Press and hold the [HOME] button, then touch [SETTINGS] → [INSTALL].

\* If the [HOME] button is released before this step has been performed, the display returns to [HOME] window.

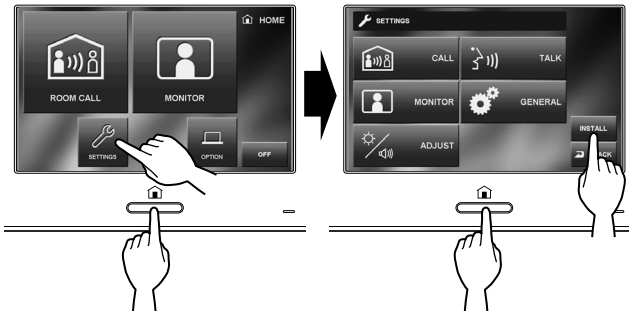

A notice message is displayed. You can release the [HOME] button.

- 3 Touch [ENTER] to continue.

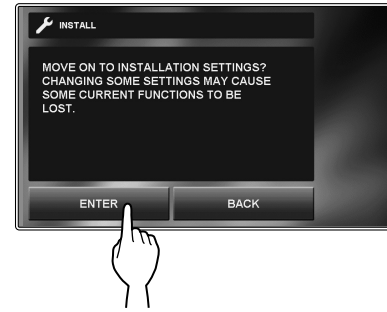

The [INSTALL] menu window is displayed.

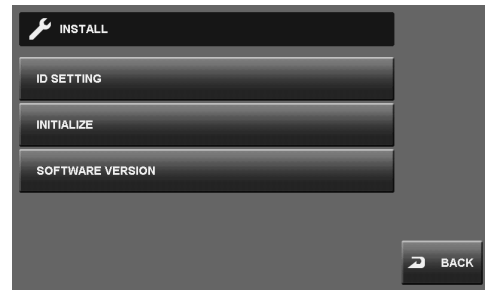

Program the settings for each item as needed.

\* If you wish to return to the previous window, touch [BACK].

## Assigning an ID to station [ID SETTING]

- \* The ID setting should be made to all the sub master stations individually.
- \* Do not assign the same ID to two or more sub master stations.

- 1 From the [INSTALL] menu window, touch **[ID SETTING]**.  
"2" to "8" are displayed.  
The current ID number is highlighted.
- 2 To change the ID number, touch the number until highlighted.
- 3 Touch **[ENTER]** to save ID.

\* When ID is changed, this station will be rebooted.

## Initializing station [INITIALIZE]

By initializing this station, all settings return to default.

- 1 From the [INSTALL] menu window, touch **[INITIALIZE]**.  
A notice message is displayed.
- 2 Touch **[YES]** to continue initializing.  
To cancel initializing, touch **[NO]**.

## Identifying software version [SOFTWARE VERSION]

You can identify the software version of this station. Use this item when doing maintenance etc.

From the [INSTALL] menu window, touch **[SOFTWARE VERSION]**.

The ID number and software version of this station will be displayed.

# PART NAMES

## Front panel

Remove protective film from screen before use.

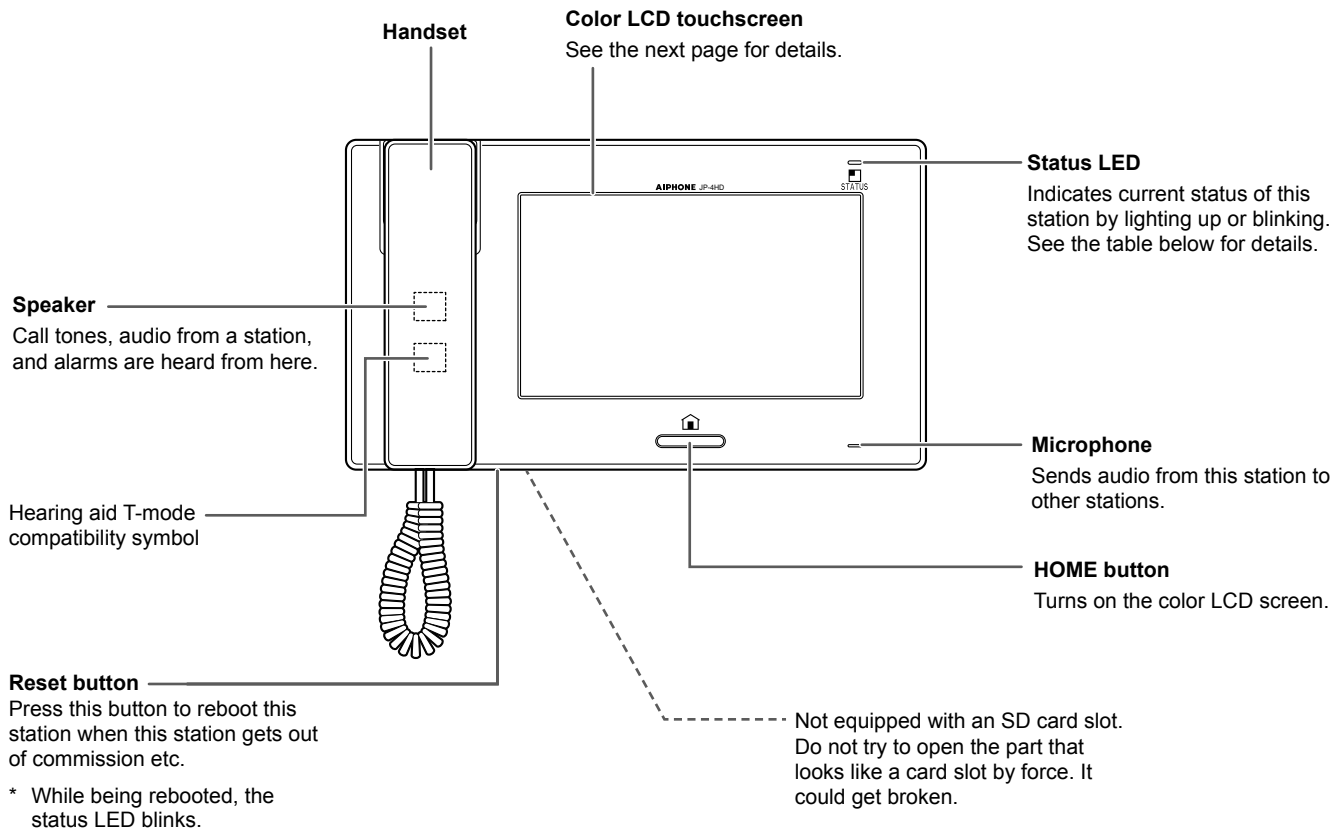

**Status LED table**

Color	Indication pattern	Station status
Orange	Blinking every 0.5 seconds	Incoming call from door station
Green	Solid light	Communicating with a door station or a residential station.
Green	Solid light	Monitoring a door station or a residential station.
Red	Solid light	Security mode is active.
Red	Blinking every 0.5 seconds	Sounding the security alarm.
Orange	Blinking every 0.5 seconds	Calling a single or all residential stations or being called from a residential station.
Light blue	Blinking every 0.5 seconds	Rebooting.

## Screen

This station features a touchscreen. Simply touch the icons or buttons displayed on the screen.  
The following are examples of typical windows and icons.

\* The displayed windows and icons may differ depending on the devices connected to this system.

### HOME window

This window appears when the screen is turned on.



### Communication with a video door station

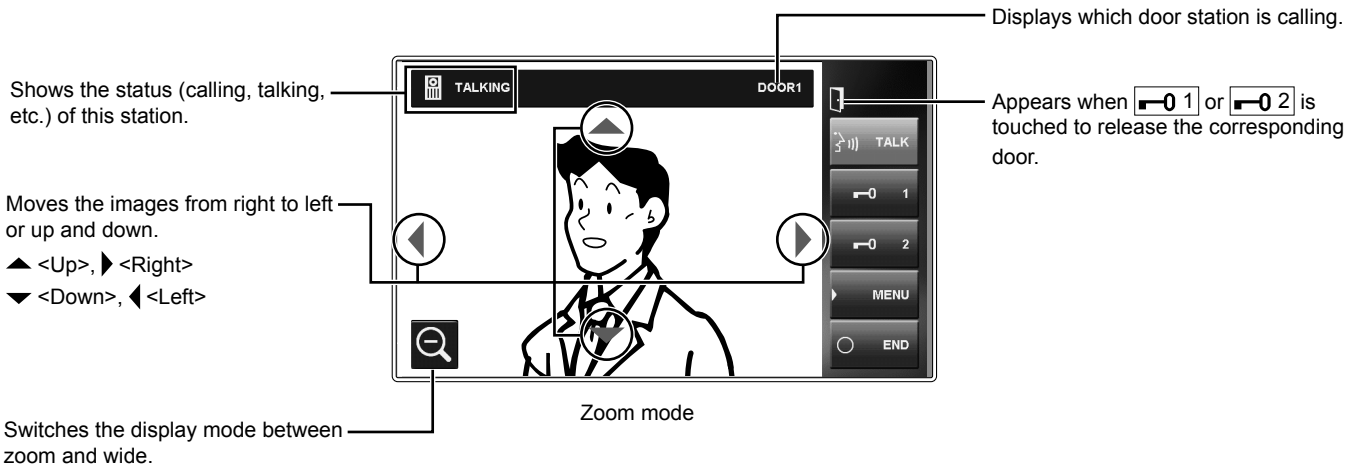

### Frequently-used icons

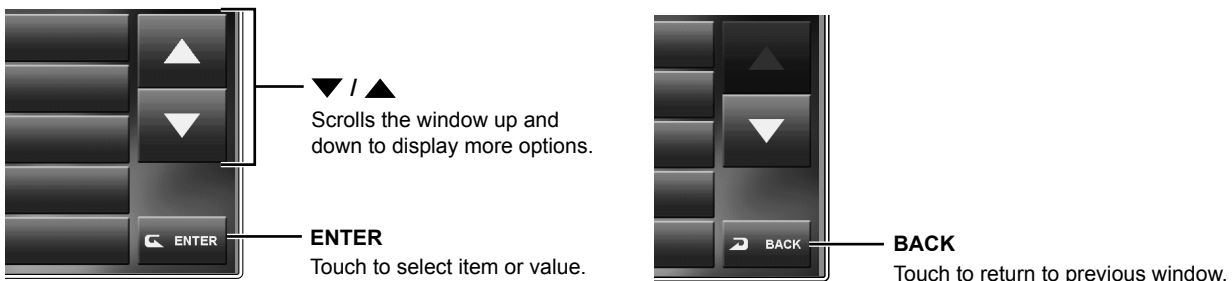

**NOTE:** The above example may differ from actual product.

# SETTING AND ADJUSTMENT

Program system settings using master station after all devices are installed. Program individual device settings on all master and sub master stations separately.

Mainly, the results of settings made on the master station are also applied to the sub master stations. The settings and adjustments to be made on an individual sub master station are as in the table below.

**NOTE:**

First change the display language for the screen to the language you need on the master station before starting the settings and adjustments on a sub master station.

## SETTING LIST

To begin, touch [SETTINGS] from HOME window to program the settings before using this station for the first time.

Category	Item	Sub item	Setting range	Default
CALL	DOOR STATION SETTINGS * <sup>1</sup>	DOOR1/DOOR2/DOOR3/DOOR4	ENABLE/DISABLE	ENABLE (for each)
	ROOM STATION CALL SETTINGS * <sup>1</sup>	ID1/ID2/ID3/ID4/ID5/ID6/ID7/ID8 (The ID number of this station is not displayed.)	ENABLE/DISABLE	ENABLE (for each)
TALK	PRIVACY MODE	-	ENABLE/DISABLE	DISABLE
MONITOR	ROOM MONITOR	-	ENABLE/DISABLE	ENABLE
GENERAL	SOUND SETTING	AUDIBLE TOUCH TONE	-	ENABLE/DISABLE
	DOOR RELEASE * <sup>1</sup>	-	DOOR1/DOOR2/DOOR3/DOOR4	ENABLE/DISABLE
	PIN SETTING	-	CURRENT PIN/ NEW PIN	(Select four numbers from 0 – 9) 1111
ADJUST		-	1 - 10	6
	VOLUME	/  /  /	0 (mute), 1 - 10	6 (for each)

**NOTES:**

- The screen will turn off if approx. one minute elapses with no operation on this station. When it occurs, if the setting is not complete, start from the beginning.
- The above list is a brief overview of the setting items available on this station. The descriptions, and the style and order of descriptions do not necessarily equate with the actual displays.

\*<sup>1</sup>: It is required to enter PIN before programming can begin.

# SETTING AND ADJUSTMENT DETAILS

## Setting the PIN [GENERAL] - [PIN SETTING]

When this station is started up for the first time or after this station is rebooted, program this setting first.

Some settings require a PIN to prevent content from being altered by unauthorized individuals.

Create a unique PIN to properly secure settings.

\* The factory default is "1111".

- 1 From HOME window, touch **SETTINGS** → **GENERAL** → **PIN SETTING**.



The current PIN entry window is displayed.

- 2 Enter the current 4-digit PIN. (For first time users, default is "1111").
- 3 Touch **ENTER**.  
The new PIN entry window is displayed.  
\* If a wrong PIN is entered, an error message will be displayed requesting the correct PIN.
- 4 Enter the new 4-digit PIN.
- 5 When the setting has finished, touch **ENTER**.  
The new PIN is memorized.

You can change the PIN any time by following the above procedure.

### NOTES:

- When this station is initialized by the [INSTALL] menu, the PIN returns to "1111" (default).
- You must keep the PIN without fail. If you forget the PIN, you must initialize this station by the [INSTALL] menu, thus all the setting contents return to default.

## Call settings [CALL]

You can make the following settings for call.

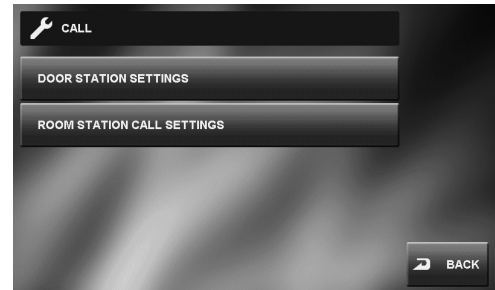

### ■ Designate door stations allowed to call-in to this station [DOOR STATION SETTINGS]

You can set whether or not this station receives a call from the door station 1 to 4. Individual settings can be programmed for each door station. When there is a call from a door station that is set to "DISABLE", no call tone sounds and no image is displayed on this station.

- 1 From HOME window, touch **SETTINGS** → **CALL** → **DOOR STATION SETTINGS**.  
The PIN entry window is displayed.
- 2 Enter the 4-digit PIN by using the touchscreen, and then touch **ENTER**.  
"DOOR1" to "DOOR4" are displayed.  
\* If a wrong PIN has been entered, an error message is displayed. Enter correct PIN.
- 3 To change the setting for "DOOR1", select "ENABLE" or "DISABLE".  
**ENABLE** .....Allows this station to receive a call from door station 1.  
**DISABLE** .....Does not allow this station to receive a call from door station 1.
- 4 Repeat for other door stations.
- 5 When the setting has finished, touch **ENTER**.

## ■ Designate residential station(s) that receive a call from this station [ROOM STATION CALL SETTINGS]

You can set whether or not the other residential stations receive a call (all call or single call) from this station. The setting can be made for each station. A station set to "DISABLE" will not receive a call from this station.

- 1 From HOME window, touch **SETTINGS** → **CALL** → **ROOM STATION CALL SETTINGS**.

The PIN entry window is displayed.

- 2 Enter the 4-digit PIN by using the touchscreen, and then touch **ENTER**.

"ID 1" to "ID 8" (other than this station) are displayed.

- "ID1" shows the master station.
- "ID2" shows the sub master station whose ID switch is set to "2". (The same applies to "ID3" to "ID8".)
  - \* The ID number of this station is not displayed.

\* If a wrong PIN has been entered, an error message is displayed. Enter correct PIN. (See page 15 for PIN settings).

- 3 To change the setting for "ID2", select "ENABLE" or "DISABLE".

**ENABLE**.....Allows the station to receive a call from this station.

**DISABLE**.....Does not allow the station to receive a call from this station.

- 4 Repeat for other stations.

\* Use "▼" or "▲" to scroll between ID numbers.

- 5 When the setting has finished, touch **ENTER**.

## Setting the microphone on/off for a call from a residential station [TALK] - [PRIVACY MODE]

This setting enables or disables the PRIVACY MODE.

When receiving a call from a residential station individually;

- When set to "ENABLE", privacy mode is set. In this state, a caller cannot hear audio from this station.
- When set to "DISABLE", audio can be heard from this station allowing for 2-way communication.

- 1 From HOME window, touch **SETTINGS** → **TALK**.

- 2 Touch **PRIVACY MODE** and select "ENABLE" or "DISABLE".

- 3 When the setting has finished, touch **ENTER**.

## Setting for indoor monitoring [MONITOR] - [ROOM MONITOR]

When set to "ENABLE", this station can be monitored by the other residential stations. When set to "DISABLE", this station cannot be monitored by other stations.

- 1 From HOME window, touch **SETTINGS** → **MONITOR**.

- 2 Touch **ROOM MONITOR** and select "ENABLE" or "DISABLE".

- 3 When the setting has finished, touch **ENTER**.



## Enabling/Disabling the operation sound [GENERAL] - [SOUND SETTING] - [AUDIBLE TOUCH TONE]

You can make this station sound a beep whenever the touchscreen is touched.

- 1 From HOME window, touch **SETTINGS** → **GENERAL** → **SOUND SETTING**.
- 2 Touch **AUDIBLE TOUCH TONE** and select "ENABLE" or "DISABLE".
- 3 Touch **ENTER** to save change.

## Enabling/Disabling door release [GENERAL] - [DOOR RELEASE]

You can make it possible (ENABLE) or not (DISABLE) to release door locks from this station.  
Set for Door 1 to Door 4 individually.

If "DOOR1" is set to "ENABLE", when receiving a call from a door station or while monitoring an entrance, **0 1** and **0 2** are displayed on the screen. Touching **0 1** activates the door release device for Door 1.

If it is set to "DISABLE", **0 1** and **0 2** are grayed out and disabled.

- 1 From HOME window, touch **SETTINGS** → **GENERAL** → **DOOR RELEASE**.
- 2 Enter the 4-digit PIN by using the touchscreen, then touch **ENTER**.  
"DOOR1" to "DOOR4" are displayed.  
\* If a wrong PIN has been entered, an error message is displayed. Enter correct PIN. (See page 15 for PIN settings).
- 3 To change the setting for "DOOR1", select "ENABLE" or "DISABLE".
- 4 Repeat for other door stations.
- 5 When the setting has finished, touch **ENTER**.

## Adjusting brightness and volume [ADJUST]

You can adjust the brightness of the screen and sound volumes.

- 1 From HOME window, touch **SETTINGS** → **ADJUST**.  
The setting window appears.

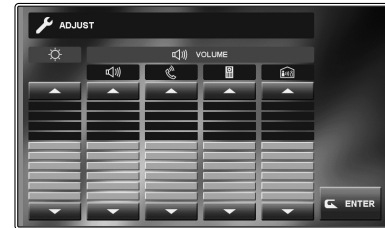

- .....Adjusts brightness of the screen.
- .....Adjusts the speaker volume when talking in hands-free mode.
- .....Adjusts the output volume when talking with handset.
- .....Adjusts the volume of call tone from door station(s).
- .....Adjusts the volume of call tone from other residential station(s).  
(for calling both a single station and all stations)

Volume adjustment range: 0 (mute), 1 - 10

- 2 Touch ▼ or ▲ to adjust the levels.
- 3 Touch **ENTER** to save change.

# USING THE SYSTEM

## ANSWERING A CALL

### When receiving a call from a door station

When there is a call from a video door station

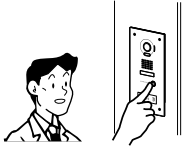

The call tone sounds, an image is on the screen, and audio from the door station can be heard.

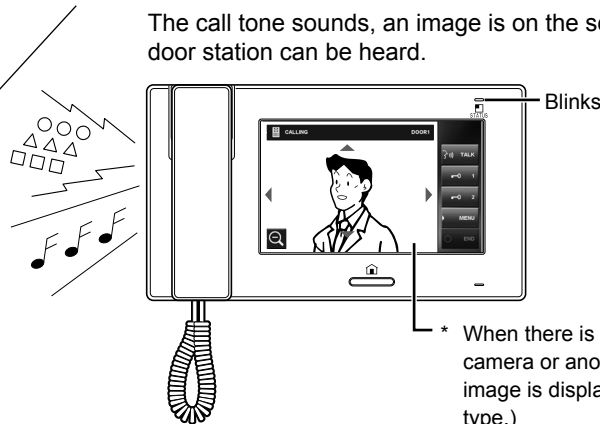

\* When there is a call from a door station without a camera or another residential station, the station type image is displayed. (The image differs from the station type.)

### Answering a call from a door station

#### To answer the call

Touch **TALK** or lift handset.



Begin talking with the caller.

\* When talking in hands-free mode, the communication status is displayed. (below)

(When talking)



Lights up.

(When listening to the caller)



Off

- \* Lift handset at any time for privacy.
- \* The display mode can be adjusted to view images. (→P. 19)

\* While communicating with the caller, unlock the door or use other features by touching the following buttons.

Adjusting images (→P. 20)    Volume (→P. 21)

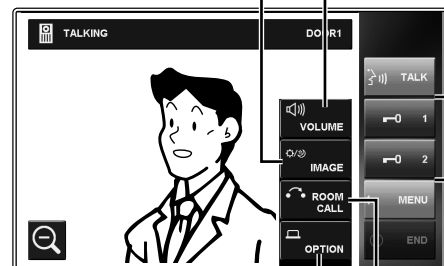

Door release (→P. 21)

OPTION (→P. 26)

Transferring (→P. 22)

\* This may not be displayed depending on the setting.

#### To complete the communication

Touch **END** on the screen, press the [HOME] button, or hang-up handset.

\* Communication also ends automatically after 1 minute in hands-free mode, or after 3 minutes using handset.

#### NOTE:

If this station is not set to receive a call from a specific door station, there will be no call tone and no image displayed while the door station is calling in to this system. (To add door, see page 15.)

## ■ Receiving a call while talking with another door station

- \* The call tone sounds in a lower volume.
- \* The video image on the screen will continue to display current call.

### To answer the second call

Conclude current talking to answer new call-in.

- \* If this station is not set to receive a specific door station, this station will not be able to answer the door station calling in to this system. (To add door, see page 15.)

## ■ Receiving a call while talking with another residential station

- \* The call tone sounds in a lower volume.
- \* The video image from the door station is displayed on the screen.
- \* The call will stop and video image will disappear when the preset call duration time elapses, then the normal talking mode is restored.

### To answer the call

Conclude talking with the residential station to answer door station.

- \* If this station is not set to receive a specific door station, this station will not be able to answer the door station calling in to this system. (To add door, see page 15.)

## Answering a call from another residential station

When receiving a call from another residential station, a call tone sounds and talking becomes enabled automatically.

- \* Communication ends automatically after approx. 10 minutes.
- \* The ID number of the calling station will not be displayed.
- \* If another residential station is calling all the other stations simultaneously, touching **TALK** or lifting handset begins communication and ends call to all other stations.
- \* Speaker volume can be adjusted during communication. (→P. 21)

### To complete communication

Touch **END** or press the **[HOME]** button.

## ■ When PRIVACY MODE is set to “ENABLE”

A calling another residential station will not hear sound or a response from this station until the call is answered by this station.



To respond to another residential station call, touch **TALK** or lift handset.

- \* Refer to page 16 for setting the PRIVACY MODE.

## Adjusting the display mode for viewing images at a video door station

You can adjust the display mode for viewing images at a video door station by using the following functions.

### ■ Switching Zoom/Wide

Touch  to zoom in. Touch  to zoom out.

Wide

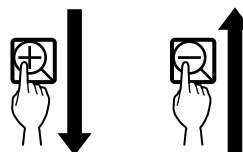
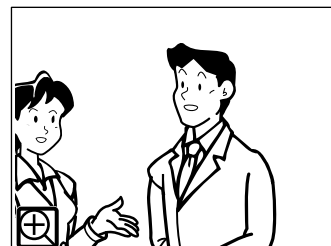

Zoom



### NOTES:

- Image will zoom to the preset position. Preset position can be adjusted on the master station. The preset position setting is applied to all the sub master stations automatically.
- Depending on the properties of the video door station camera, the wide image may appear more distorted than the zoom image. This is not a malfunction.
- In zoom mode, the image can be moved from right to left or up and down. (→P. 20)

## ■ Pan & Tilt

When a zoom image is displayed, touching ▲, ▼, ◀, ▶ on the screen moves the image as shown below.

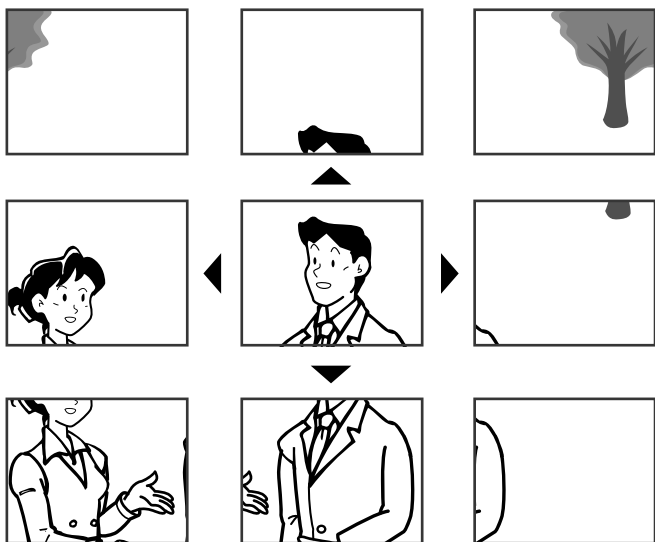

### NOTES:

- The image range of the zoom mode and wide mode differs. The edge of wide image will not be displayed with the zoom mode.
- At night, the image quality is degraded.
- At night, the object image may be blurred and less-visible when moving from right to left or up and down because illumination is reduced. The same applies to a moving object.

### If a CCTV camera is connected instead of a video door station at entrance:

Zoom/Wide and Pan & Tilt functions are disabled.

## Adjusting images [IMAGE]

While communicating with a door station, you can adjust the screen brightness and viewability of images.

\* Adjustment can also be made while receiving a call from, communicating with, or monitoring a video door station (when [MENU] is displayed on the screen).

## ■ Adjusting screen brightness [☀]

You can adjust the brightness of the screen in 10 levels.

1 Touch [MENU] → [IMAGE].



The setting window appears.

2 Touch ☀ - ▼ or ▲ to change the level.

## ■ Adjusting viewability of images [ADJUST]

If the image on the screen is hard to see due to bright light, adjust settings.

### NOTE:

This function is not available for an image from a CCTV camera.

### Bright light conditions (Day)

1 When an image is displayed, touch [MENU] → [IMAGE].

The setting window appears.

2 Touch [ADJUST].

A backlight adjustment is made to brighten the image.

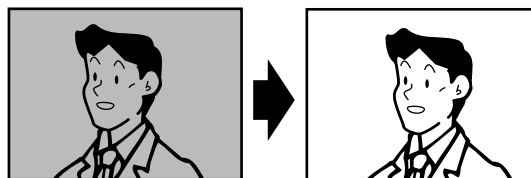

### To return the adjustment to default

Touch [ADJUST] again.

### NOTES:

- The discrimination between day and night is performed automatically by the door station.
- On the master station, you can preset the backlight adjustment so that it is automatically activated whenever starting displaying an image during the day. This setting is also applied to all sub master stations automatically.

### Dim light conditions (Night)

1 When an image is displayed, touch [MENU] → [IMAGE].

The setting window appears.

2 Touch [ADJUST].

The image becomes more visible.

### To return the adjustment to default

Touch [ADJUST] again.

### NOTES:

- Any lighting adjustments return to default when the screen is turned off.
- [ADJUST] changes camera shutter speed. As a result, visitor's face will be brighter but moving objects may appear blurred.

## Adjusting the speaker or handset volume [VOLUME]

Volume can be adjusted at any time.



Adjusting range: 0 (mute), 1 - 10.



- \* This adjustment can be made while receiving a call, during communication, or while monitoring a station.
- \* "🔊" is displayed both when adjusting the speaker and handset volume.

- 1 Touch **MENU** → **VOLUME**.  
The setting window appears.
- 2 Touch ▼ or ▲ to reach desired level.

## Door release [DOOR RELEASE]

Door release can be activated during a call-in, communication, or while monitoring a door station.

- \* Release a door when  is displayed on the screen.
  - If  is grayed out (disabled), check [DOOR RELEASE], and change if needed. (→P. 17)
  - It may not be possible to enable  at [DOOR RELEASE] if it is set to be disabled by the [INSTALL] menu on the master station.

Touch either  or  to release door.





The door lock is released for the set door release time.

- \* If the door release time is set to "MOMENTARY" by the [INSTALL] menu on the master station, it will be released for as long as the button is held.

### CAUTION:

Always confirm visitor identity if the door station has no camera.

### When using JP-DVF-L, a video door station (guidance-enabled type)

JP-DVF-L has an output for door release etc. When receiving a call from or communicating with JP-DVF-L, touching  or  releases the door lock device etc. connected with the JP-DVF-L for the set door release time.

## Transferring a door call to another residential station [ROOM CALL]

You can transfer a call received from a door station to a single or all the other residential stations while communicating with it.

- 1 While talking with the door station, touch **MENU** → **ROOM CALL**.



- 2 Select another residential station, or touch **ALL CALL** to transfer the call to all other residential stations.

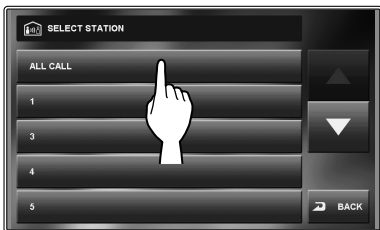

\* Communication with the door station is suspended while forwarding call to residential stations.



Your speaking is heard and the image of the door station is displayed on the target residential station(s).

- 3 When someone touch **TALK** or lift handset on the target residential station (or one of the target stations), talking begins with the target station side.
- 4 Say that you will transfer the call from a door station to the target station, and then touch **END**.  
At the same time, the communication between you and the door station ends
- 5 When someone touches **TALK** or lifts handset on the target station, he (or she) can talk with the door station side.

\* If handset is lifted in step 3, hang up once and then lift handset again to talk with the door station side.

## Priority of actions

The order of priority for two or more actions (communication, calling, monitoring, etc.) performed at the same time is as follows.

Priority	Action
1 (high)	Triggering alarm (SECURITY)
2	Triggering alarm (OPTION) (when "ALARM AT DOOR" is set to "ENABLE")
3	Communication with another station
4	Receiving a call from a door station
5	Calling all or a single residential station
6	Triggering alarm (OPTION) (when "ALARM AT DOOR" is set to "DISABLE")
7 (low)	Monitoring

- \* Later call from a door station has priority over earlier call from another door station.  
When this station is receiving a call from a residential station, other residential stations cannot be used.
- \* You can call and talk to all or a single residential station while communicating with a door station.
- \* Later monitoring has priority over earlier one.

# CALLING/MONITORING OTHER STATIONS

\* Communication with a door station ends automatically after 1 minute in hands-free mode, or after 3 minutes using handset. Communication with a residential station ends automatically after approx. 10 minutes.

## Calling all residential stations simultaneously

\* Residential stations must be set to receive a call from this station.

- 1 Press the [HOME] button, touch screen, or lift handset.
- 2 Touch **ROOM CALL** from HOME window.
- 3 Touch **ALL CALL**.

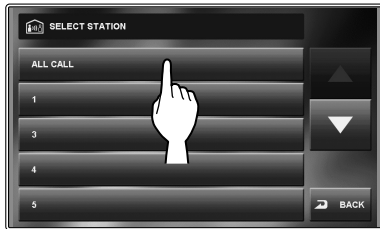

A call tone sounds on all the residential stations receiving the call.



After the call tone, audio from this station is heard at the target stations.  
The station type image of this station is displayed on the screens of the target stations.

- 4 Begin talking.
  - \* Audio from the target stations cannot be heard.
- 5 If someone touches **TALK** or lifts handset at one of the target stations, communication between this station and the target station is initiated.

### To complete communication

Do one of the following.

- Touch **END** on the screen.
- Hang up handset.
- Press the [HOME] button.

## Calling another residential station

\* Residential stations must be set to receive a call from this station.

- 1 Press the [HOME] button, touch screen, or lift handset.
- 2 Touch **ROOM CALL** from HOME window.
- 3 Touch the target station.

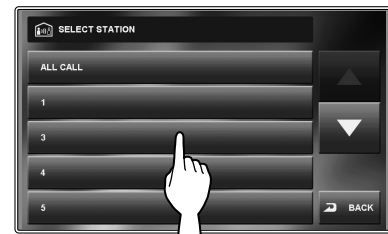

\* Use "▼" or "▲" to scroll between stations.

A call tone sounds at this station and the target station.

- 4 Hands-free communication between stations can be used.
  - \* If the PRIVACY MODE is set to "ENABLE" on the target station, you cannot hear audio from the target station. In such a case, you can talk with the target station side if handset is lifted or **TALK** is touched on the target station.

### To complete communication

Do one of the following.

- Touch **END** on the screen.
- Hang up handset.
- Press the [HOME] button.

## Monitoring

You can monitor a door station or another residential station.

### ■ Monitoring door station (entrance)

\* When monitoring an audio door station, only audio from the station is available. When monitoring a video door station, audio and video images are available.

- 1 Press the [HOME] button or touch screen.
- 2 Touch **MONITOR** from HOME window and select the door station to monitor.



Audio will be heard and if the station has a camera, images can be viewed.

- \* During monitoring, audio cannot be heard with handset.
  - \* If there is a visitor at the entrance, touch **TALK** or lift handset to begin communication.
- 3 To end monitoring;  
Touch **BACK** on the screen or press the [HOME] button.

#### Available functions during monitoring

- Zoom/Wide camera control (→P. 19)
  - \* When monitoring is started, an image is shown in wide mode.
- Pan & Tilt (→P. 20)
- Adjusting images (→P. 20)
- Door release (→P. 21)
- Volume control (→P. 21)
- **OPTION** (→P. 26)

#### If a CCTV camera is connected instead of a video door station at entrance:

Audio monitoring and communication is available if an audio door station is connected with a CCTV camera.

#### NOTES:

- Monitoring ends automatically after set time.
- The night illumination is automatically activated on door station, depending on settings.

### ■ Monitoring residential station (Audio only)

You can monitor sounds at another residential station.

- 1 Press the [HOME] button, touch screen, or lift handset.
- 2 Touch **MONITOR** from HOME window and select the station to monitor.  
  
A call tone sounds at both this station and target station, and then the symbol image for monitoring is displayed on the screens of both stations.
  - \* Use "▼" or "▲" to scroll between stations.
- 3 Audio from the target station can be heard at this station.
  - \* If there is no operation for approx. 1 minute, the screen turns off. (The monitoring is continued.)
  - \* If you have received a call from another station, monitoring is temporarily suspended. Monitoring resumes after call is finished.
- 4 To end monitoring;  
Touch **BACK** on the screen or press the [HOME] button on this station.

#### NOTES:

- An alert will sound if another residential station has disabled the audio monitoring feature.
- While monitoring a residential station, no operation is possible on the target station. To end monitoring, make an ending operation on this station.
- A new monitoring action takes priority over current monitoring. During monitoring, for example, if another station starts monitoring this station, current monitoring by this station is cancelled.
- Monitoring ends automatically after a lapse of set time.



# USING THE SECURITY FUNCTION

\* This function is available when the inputs 1, 2, and/or 3 of the master station are set to "SECURITY", and a sensor is connected to each of the inputs.

The security mode can be set and activated on the master station. The following two security modes are available.

## ■ ARMED

Security mode when you are present.

The alarm gets enabled when the security mode is turned active.

## ■ ARMED AWAY

Security mode when you leave home/office. Set a delay time for the alarm to enable after the security mode is activated.

## When a sensor is triggered

A message is displayed, the sensor ID number is shown, the status LED blinks in red and an alarm sounds on all the residential stations.

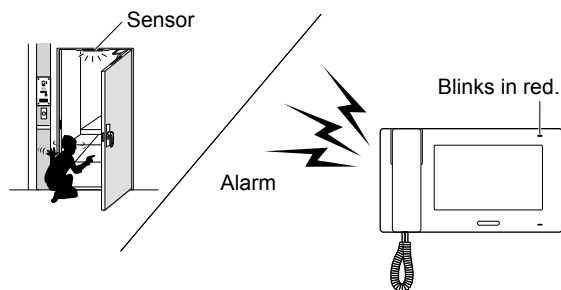

## NOTES:

- The alarm sounds in the maximum volume (10) even if the volume of call tone is set to 0.
- Door station 1 also sounds alarm and turns on the white LED.
- All the functions of this station are available while security is on.

## To stop alarm

\* When "ARMED AWAY" mode is activated and the delay time is set; if a sensor is triggered before the delay time elapses, the preliminary alarm sounds. The alarm sounds after the delay time elapses.

### [When there is no ALARM PIN]

Touch **RESET**.

### [When there is an ALARM PIN]

\* The ALARM PIN can be set on the master station only.

**1** Touch **RESET**.

**2** Enter the ALARM PIN and touch **ENTER**.

This station turns into the standby mode.

\* If a wrong ALARM PIN has been entered, an error message is displayed. Enter correct ALARM PIN.

# FUNCTIONS COMBINED WITH EXTERNAL DEVICES

## Triggering an alarm by using an external device

- \* This is available when the inputs 1, 2, and/or 3 of the master station are set to "UTILITY", and an external device, such as a sensor or a call button, is connected to each of the inputs.

### When an external device is triggered

A message is displayed, the external device ID is shown, and an alarm sounds on all the residential stations.

- \* The alarm will not sound when "ALARM AT DOOR" is set to "DISABLE" and the volume of call tone from a residential station is set to 0.

### To stop the alarm

Touch **RESET**, or press the [HOME] button.

#### NOTE:

If two or more inputs are triggered, the latter one takes priority.

## Releasing a door with another door release button

- \* This is available when one or two door release buttons are connected to the external door release inputs 1 and/or 2 of this station.

The door at the door station 1 or 2, or both doors can be unlocked by pressing the connected button(s) during a call-in, communication, or while monitoring a door station.

## Activating an external device

- \* This is available when an external device is connected to the option contact outputs of the master station.

### Activating external device

Touch **OPTION** from HOME window or while communicating with/monitoring a door station. The device will be triggered.

### Transferring alarm to external device

When detecting designated action, this station transfers alarm to the device.

#### NOTE:

**OPTION** is not displayed on the screen.

## Using a foot switch

- \* This is available when a foot switch is connected to the external talk inputs of this station.

A foot switch works similarly to touching **TALK** or **END** on the touchscreen.

## TECHNICAL PRECAUTIONS

### Cleaning:

Clean all units with a soft cloth and gentle cleaner. Do not spray cleaner directly on unit. Do not use an abrasive cleaner or cloth.

Door stations are water resistant.

### Trouble:

When this station gets out of commission, reboot this station by pressing the reset button.

## SPECIFICATIONS

Power supply	DC 24V (from power supply)
Current consumption	200 mA
Communication	Handset: Simultaneous communication Hands-free: Auto-voice actuation
Ambient temperature	0 - 40°C (+32°F - +104°F)
Dimensions	255 (W) x 145 (H) x 30 (D) mm 10-1/16" (W) x 5-3/4" (H) x 1-3/16" (D)
Screen	7 inch color LCD screen
Mounting	Wall-mount
Electrical box	3-gang box
Material	Flame resistant ABS resin
Color	White
Mass	Approx. 780g (1.72 lbs.)

# WARRANTY

Aiphone warrants its products to be free from defects of material and workmanship under normal use and service for a period of two years after delivery to the ultimate user and will repair free of charge or replace at no charge, should it become defective upon which examination shall disclose to be defective and under warranty. Aiphone reserves unto itself the sole right to make the final decision whether there is a defect in materials and/or workmanship; and whether or not the product is within the warranty. This warranty shall not apply to any Aiphone product which has been subject to misuse, neglect, accident, power surge, or to use in violation of instructions furnished, nor extended to units which have been repaired or altered outside of the factory. This warranty does not cover batteries or damage caused by batteries used in connection with the unit. This warranty covers bench repairs only, and any repairs must be made at the shop or place designated in writing by Aiphone. This warranty is limited to the standard specifications listed in the operation manual. This warranty does not cover any supplementary function of a third party product that is added by users or suppliers. Please note that any damage or other issues caused by failure of function or interconnection with Aiphone products is also not covered by this warranty. Aiphone will not be responsible for any costs incurred involving on site service calls. Aiphone will not provide compensation for any loss or damage incurred by the breakdown or malfunction of its products during use, or for any consequent inconvenience or losses that may result.

The object area of  is the EU.

## FCC

This device complies with Part 15 of the FCC Rules. Operation is subject to the following two conditions: (1) this device may not cause harmful interference, and (2) this device must accept any interference received, including interference that may cause undesired operation.

This equipment has been tested and found to comply with the limits for a Class B digital device, pursuant to Part 15 of the FCC Rules. These limits are designed to provide reasonable protection against harmful interference in a residential installation. This equipment generates, uses, and can radiate radio frequency energy, and if not installed and used in accordance with the instructions, may cause harmful interference to radio communications. However, there is no guarantee that interference will not occur in a particular installation. If this equipment does cause harmful interference to radio or television reception, which can be determined by turning the equipment off and on, the user is encouraged to try to correct the interference by one or more of the following measures:

- Reorient or relocate the receiving antenna
- Connect the equipment to an outlet on a circuit different from that to which the receiver is connected. Increase the separation between the equipment and receiver.
- Consult the dealer or an experienced radio/TV technician for help.

 **AIPHONE**®  
*Providing Peace of Mind*  
<http://www.aiphone.net/>